

DX series touch panel



DX5



1. Technical Specs:

DX5 Dimming Touch Panel

- Input Voltage: AC100~240V
- Output Signal: RF 2.4G + DMX512
- RF Remote Distance: 30m
- Control Mode: 4 Zones Control
- Working Temperature: -20°C~60°C
- Package Size: L113×W112×H50(mm)
- Weight(N.W.): 225g

R4-5A CV Receiver

- Input Voltage: DC5V~DC24V
- Max Current Load: 5A × 4CH Max. 20A
- Max Output Power: 100W/240W/480W(5V/12V/24V)
- Working Temperature: -30°C~55°C
- Package Size: L178×W48×H33(mm)
- Weight(G.W.): 150g

R4-CC CC Receiver

- Input Voltage: DC12V~DC48V
- Output Voltage: DC3V~DC46V
- Output Current: CC 350/700/1050mA×4CH
- Output Power: 1.05W~48.3W×4CH Max 193.2W
- Working Temperature: -30°C~55°C
- Package Size: L178×W48×H33(mm)
- Weight(G.W.): 165g

2. Product Size:

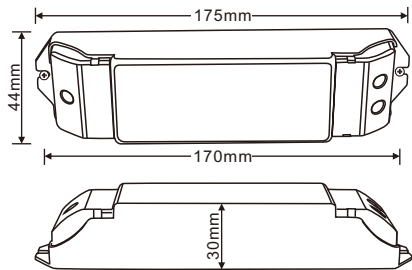

R4-5A/R4-CC Receiver

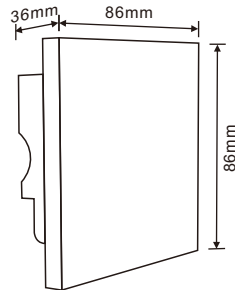

Touch Panel

3. Installation Instruction:

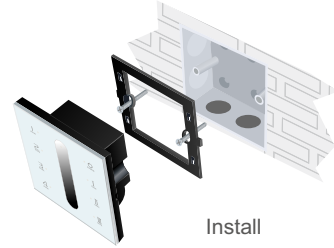

Install

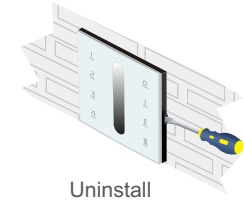

Uninstall

4. Key Functions:

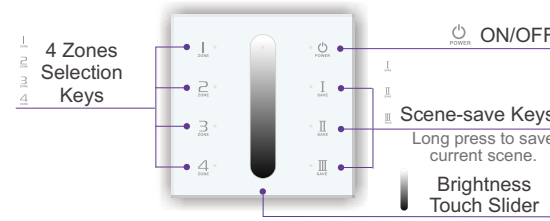

* Long press to turn on/off the tone.

5. Terminals:

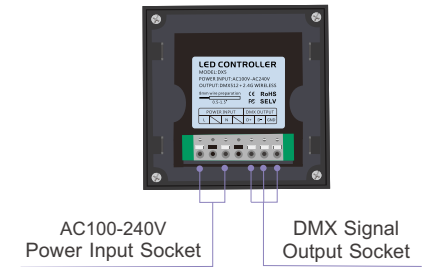

6. Operating Instruction for Receiver:

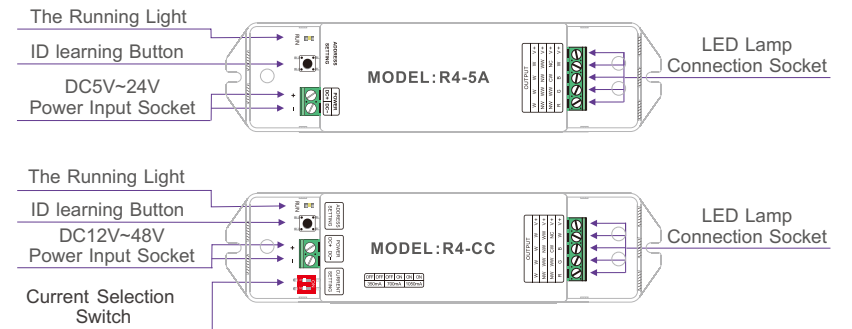

(Operation Table)

OFF	OFF	OFF	ON	ON	ON
350mA	700mA	1050mA			

7. The Learning ID Method :

Learning ID: Short press "ID learning button" on the R4-5A/R4-CC receiver, the running light keeps on. Then press any zone No. on the DX5 touch panel, the running light flickers several times, activated. the receiver accept zone control.

Canceling ID: Long press "ID learning button" on the R4-5A/R4-CC receiver for 5s, the running light flickers several times, canceled.

Att: Multiple receivers could be synced to each zone.

8. Wiring Diagram 1 (Wireless Control):

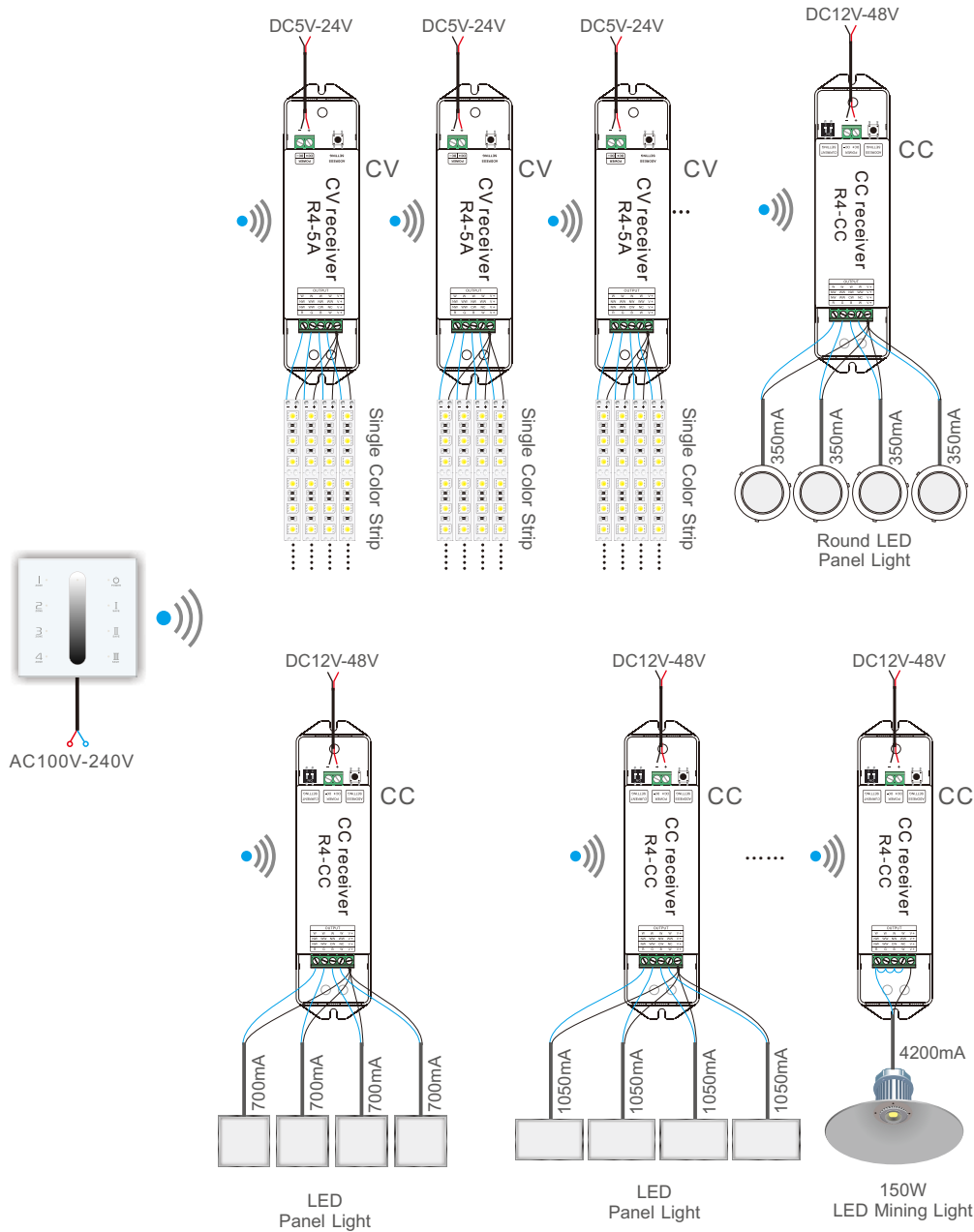

9. Wiring Diagram 2 (Connect to DMX Decoder):

